

DESCRIPTION

Vitreous China Floor-Mounted Pressure Assisted Water Closet.

COMPONENTS

- Bowl: Code 2108009
- Tank: Code 2108016

DETAILS

- Flush Volume: 1.0 gpf (3.8 Lpf)

FEATURES

- White Vitreous China
- Elongated bowl
- Floor mounted, floor outlet
- 12" (305mm) rough-in
- Chrome metal flush handle
- Secure, anti-rocking 3-point tank mounting system
- Powered by Flushmate® brand pressure assisted flushing technology to achieve 1,000g MaP score
- Over 60 ft (18.3 m) drainline carry performance
- Water spot area: 11 ¼ x 9¾ (286 mm x 248 mm)
- Smooth, quiet cable activated flush handle - left hand
- Closet bolts and caps included
- Toilet seat and wax ring not included

PLUMBING SYSTEM REQUIREMENTS

- Maximum Static Pressure: 80 PSI (552 kPa)
- Minimum Static Pressure: 25 PSI (172 kPa)

DOWNLOADS

- [Pressure-Assisted Installation Instructions](#)
- [Flushmate Owner's Manual](#)
- [Pressure-Assisted Repair and Maintenance Guide](#)
- [Additional Downloads](#)



COMPLIANCES & CERTIFICATIONS



(cUPC Green Certified, WaterSense Listed, CalGreen Compliant, CEC Compliant, NOM Certified)

NOTES

All vitreous china dimensions shown in these drawings are nominal and not to scale. Dimensions can vary within the tolerances established in the governing ASME A112.19.2/CSA B45.1 standard. It is important to consider this when planning rough-in and plumbing layouts.

All information contained within this document subject to change without notice.

ROUGH-IN

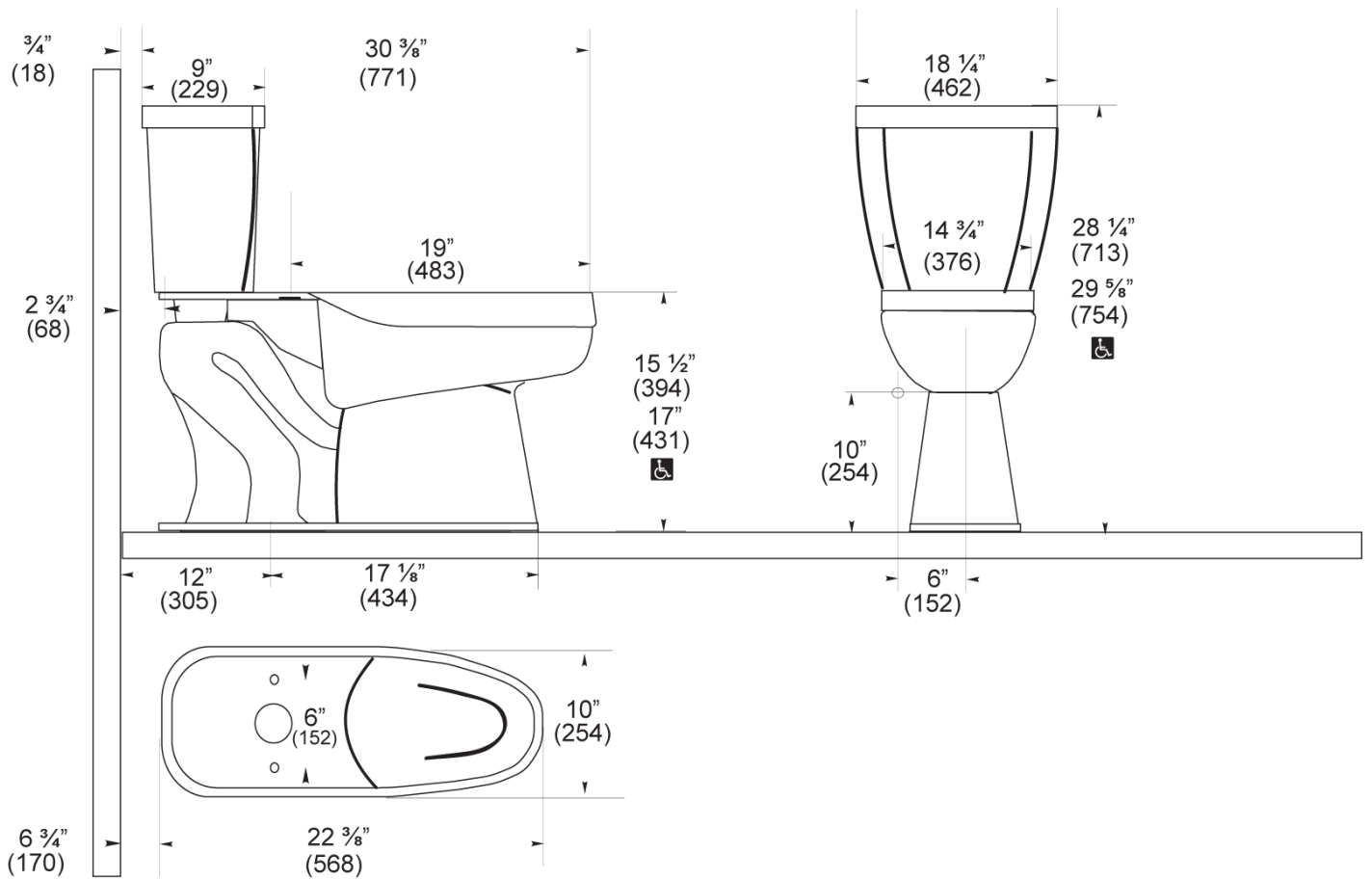

Sloan 10500 Seymour Ave, Franklin Park, IL 60131
Phone: 800.982.5839 • Fax: 800.447.8329 • sloan.com