

**DESCRIPTION**

Estándar, Cerámica Piso-Montado Apto para Discapacitados Pressure Assisted Water Closet.

**COMPONENTS**

- Bowl: Code 2108029
- Tank: Code 2108016

**DETAILS**

- Flush Volume: 1.0 gpf (3.8 Lpf)

**FEATURES**

- White Vitreous China
- Elongated bowl
- Floor mounted, floor outlet
- 12" (305mm) rough-in
- Chrome metal flush handle
- Secure, anti-rocking 3-point tank mounting system
- Powered by Flushmate® brand pressure assisted flushing technology to achieve 1,000g MaP score
- Over 60 ft (18.3 m) drainline carry performance
- Water spot area: 11 ¼ x 9¾ (286 mm x 248 mm)
- Smooth, quiet cable activated flush handle - left hand
- Closet bolts and caps included
- Toilet seat and wax ring not included

**PLUMBING SYSTEM REQUIREMENTS**

- Maximum Static Pressure: 80 PSI (552 kPa)
- Minimum Static Pressure: 25 PSI (172 kPa)

**DOWNLOADS**

- [Pressure-Assisted Installation Instructions](#)
- [Flushmate Owner's Manual](#)
- [Pressure-Assisted Repair and Maintenance Guide](#)
- [Additional Downloads](#)

**COMPLIANCES & CERTIFICATIONS**

(cUPC Green Certified, ADA Compliant, WaterSense Listed, CalGreen Compliant, CEC Compliant, NOM Certified)

**NOTES**

All vitreous china dimensions shown in these drawings are nominal and not to scale. Dimensions can vary within the tolerances established in the governing ASME A112.19.2/CSA B45.1 standard. It is important to consider this when planning rough-in and plumbing layouts.

All information contained within this document subject to change without notice.

**ROUGH-IN**

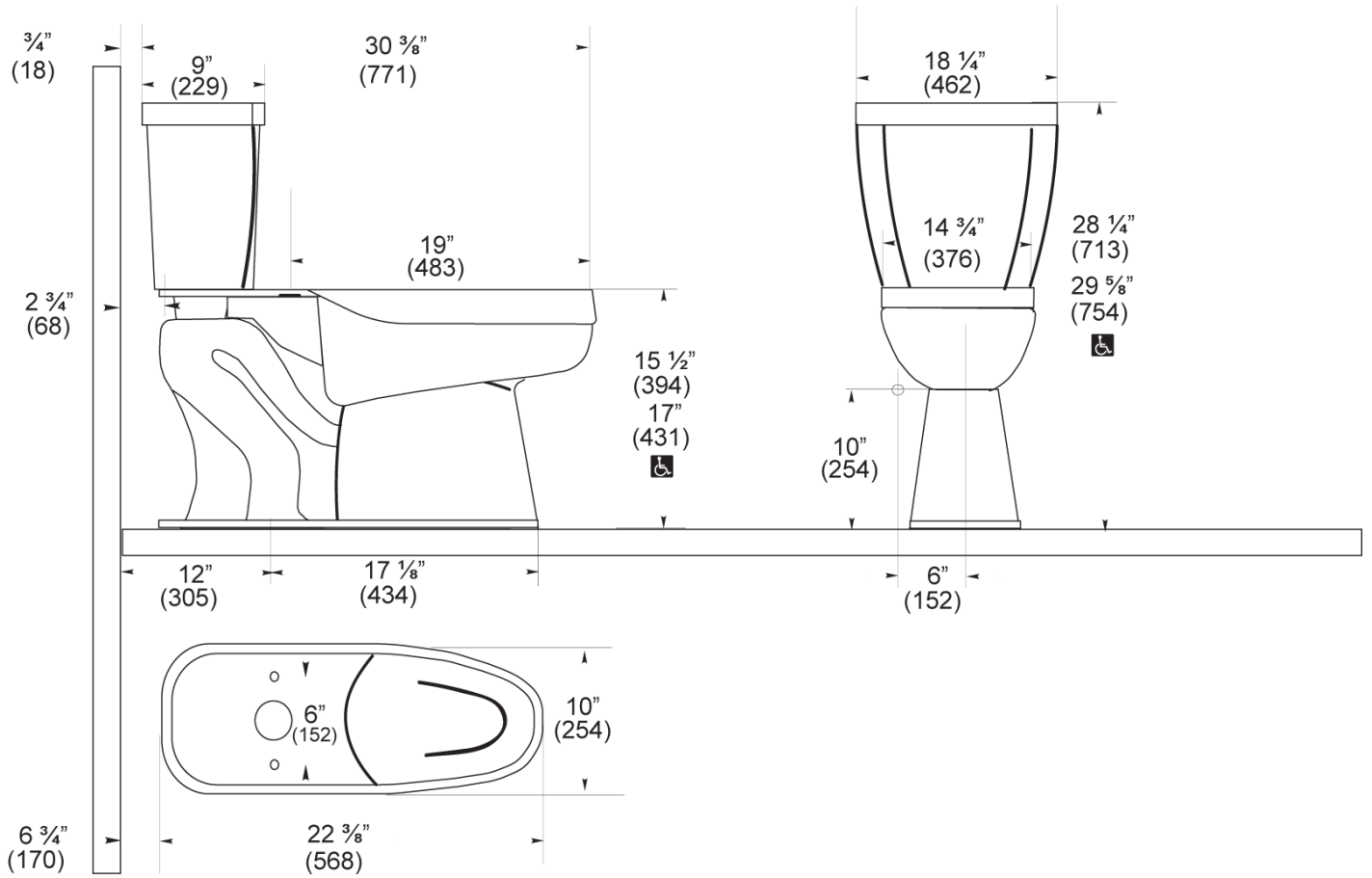

Sloan 10500 Seymour Ave, Franklin Park, IL 60131

Phone: 800.982.5839 • Fax: 800.447.8329 • [sloan.com](http://sloan.com)